

3 601 D40 300

Issue } 10-10-12 **Fig./Abb. 1**
Stand }

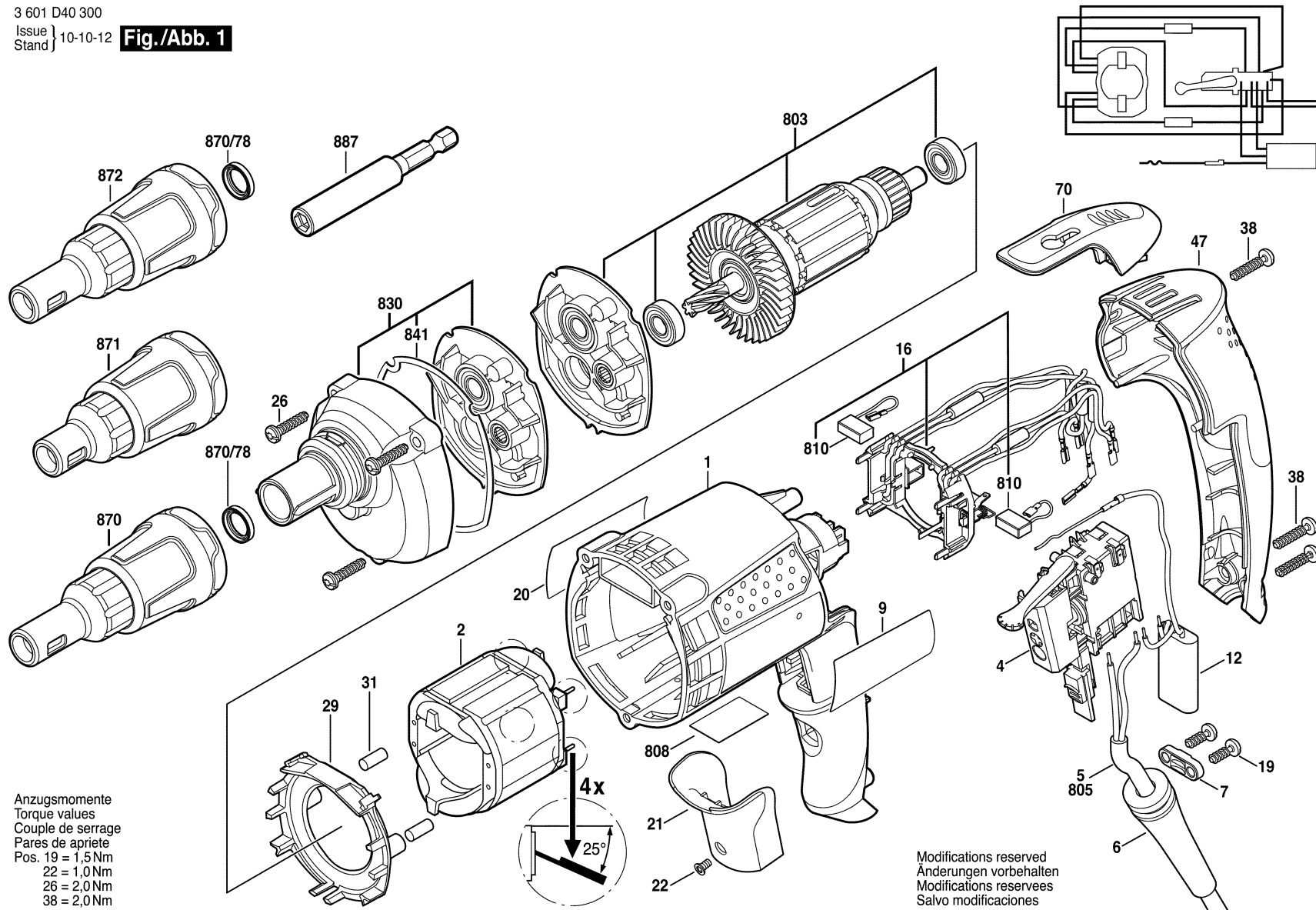

Anzugsmomente
Torque values
Couple de serrage
Pares de apriete
Pos. 19 = 1,5Nm
22 = 1,0Nm
26 = 2,0Nm
38 = 2,0Nm

Modifications reserved
Änderungen vorbehalten
Modifications reserves
Salvo modificaciones