

0 611 253 703

Issue } 11-02-22 **Fig. /Abb. 2**
Stand }

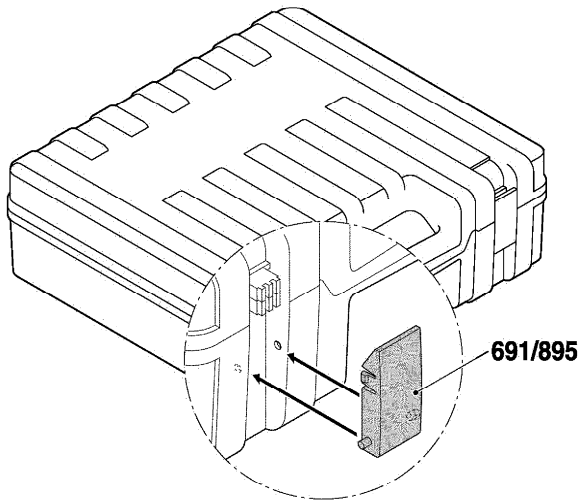
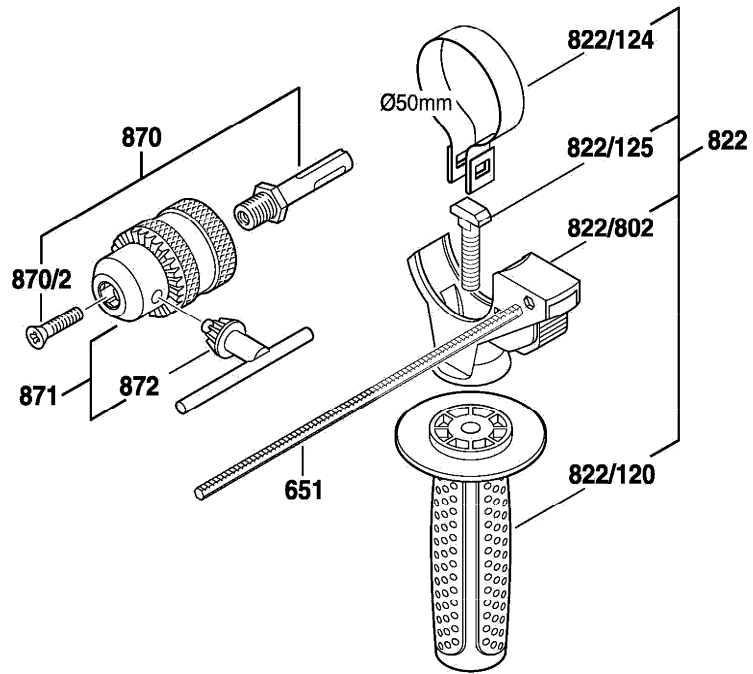

Modifications reserved
Änderungen vorbehalten
Modifications réservées
Salvo modificaciones